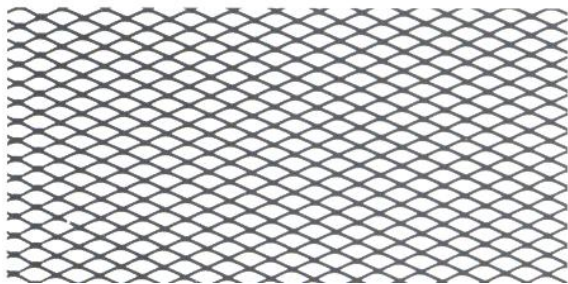
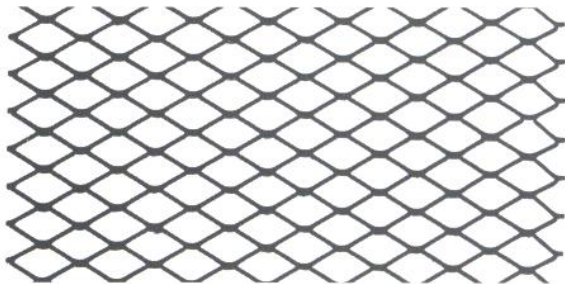
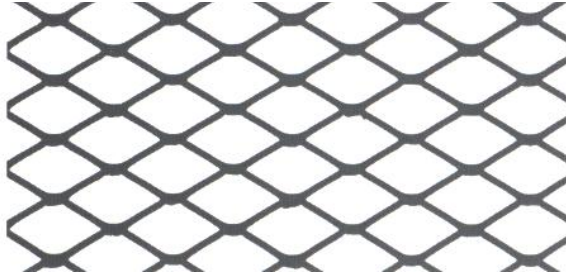
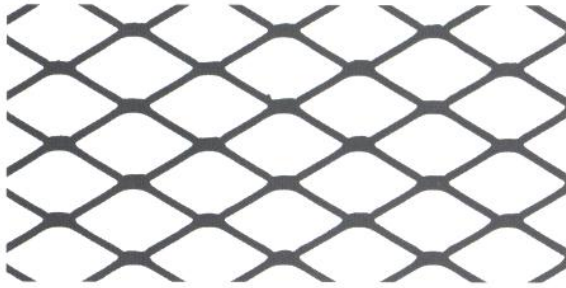

Lagermaschen: Streckgitter / Streckmetall

Typ 6 1000 x 2000 mm				
Material	Maschenlänge in mm	Maschenbreite (variabel) in mm	Stegbreite in mm	Stegdicke in mm
Stahl	6	3,2	1,0	0,5
	6	3,2	0,8	0,63
Aluminium	6	3,2	1,0	0,5
Abbildung				
				

Typ 10 1000 x 2000 mm				
Material	Maschenlänge in mm	Maschenbreite (variabel) in mm	Stegbreite in mm	Stegdicke in mm
Stahl	10	5	1,5	1,0
	10	5	1,0	0,5
Edelstahl (1.4301)	10	4,5	1,0	0,5
Aluminium	10	5	1,5	0,8
	10	5	1,0	0,5
Abbildung				
				

Typ 16 1000x 2000 mm				
Material	Maschenlänge in mm	Maschenbreite (variabel) in mm	Stegbreite in mm	Stegdicke in mm
Stahl	16	6,5	1,0	1,0
	16	6,5	1,5	0,5
Edelstahl (1.4301)	16	7	1,0	1,0
Aluminium	16	6,5	1,0	1,0
Abbildung				
				

Typ 20 1000 x 2000 mm				
Material	Maschenlänge in mm	Maschenbreite (variabel) in mm	Stegbreite in mm	Stegdicke in mm
Stahl	20	6,0	1,5	1,0
	20	6,5	2,0	1,0
Abbildung				
				

Typ 28 1000 x 2000 mm				
Material	Maschenlänge in mm	Maschenbreite (variabel) in mm	Stegbreite in mm	Stegdicke in mm
Stahl	28	7	1,25	1,0
	28	8	2,0	1,5
	28	9	2,5	1,0
	28	10	2,0	1,5
	28	10	3,0	2,0
Edelstahl (1.4301)	28	10	2,0	1,5
	28	10	2,5	1,0
Aluminium	28	10	2,0	1,5

Abbildung

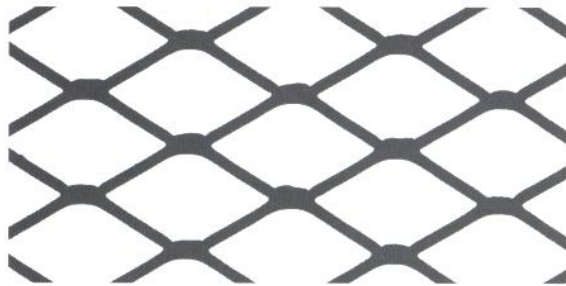

Typ 42 1000 2000 mm				
Material	Maschenlänge in mm	Maschenbreite (variabel) in mm	Stegbreite in mm	Stegdicke in mm
Stahl	42	12	2,5	1,0
	42	13	2,5	1,5
	42	13	3,0	2,0
	42	19	3,0	2,0
Edelstahl (1.4301)	42	13	2,5	1,5
	42	14	2,0	1,0
	42	19	3,2	2,0

Abbildung

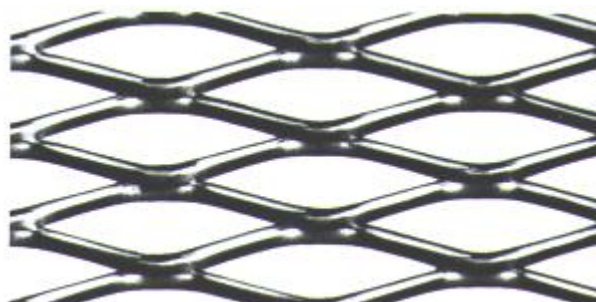

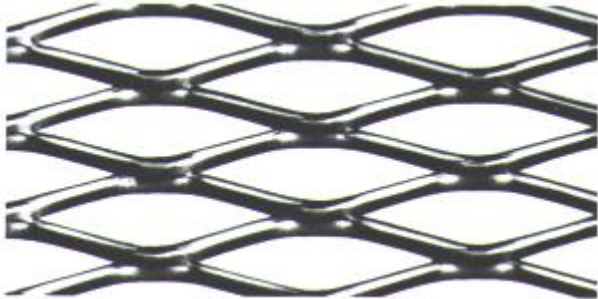
Typ 43 1000 x 2000 mm + 1250 x 2500 mm				
Material	Maschenlänge in mm	Maschenbreite (variabel) in mm	Stegbreite in mm	Stegdicke in mm
Stahl	43	13	3,0	3,0
	43	13	3,0	2,0
Abbildung				
				

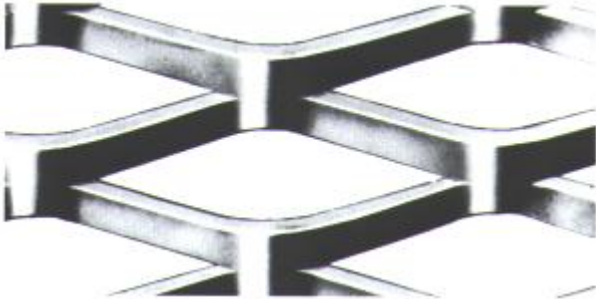
Typ 62 1000 x 2000 mm				
Material	Maschenlänge in mm	Maschenbreite (variabel) in mm	Stegbreite in mm	Stegdicke in mm
Stahl	62	23	2,5	2,0
	62	23	3,0	3,0
	62	23	4,5	3,0
	62	23	6,0	3,0
	62	23	7,0	3,0
	62	23	6,5	4,0
Abbildung				
				

Typ 115 1000 x 2000 mm				
Material	Maschenlänge in mm	Maschenbreite (variabel) in mm	Stegbreite in mm	Stegdicke in mm
Stahl	115	40	3,0	2,0
	115	40	4,5	3,0
	115	40	6,0	3,0
	115	40	9,0	4,0
Abbildung				
